

G124

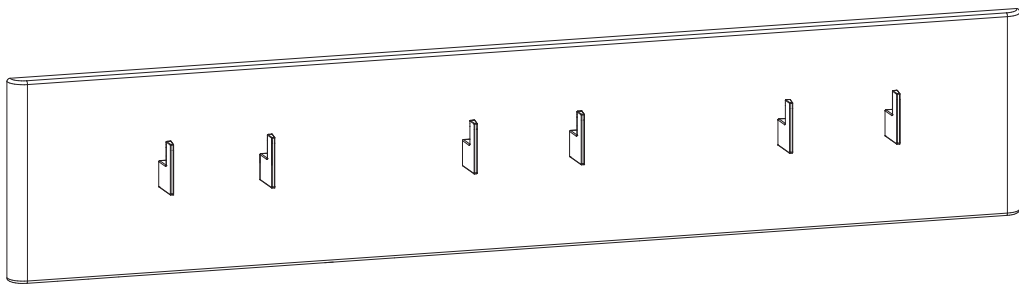

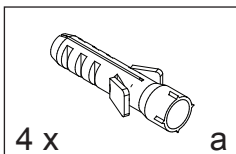
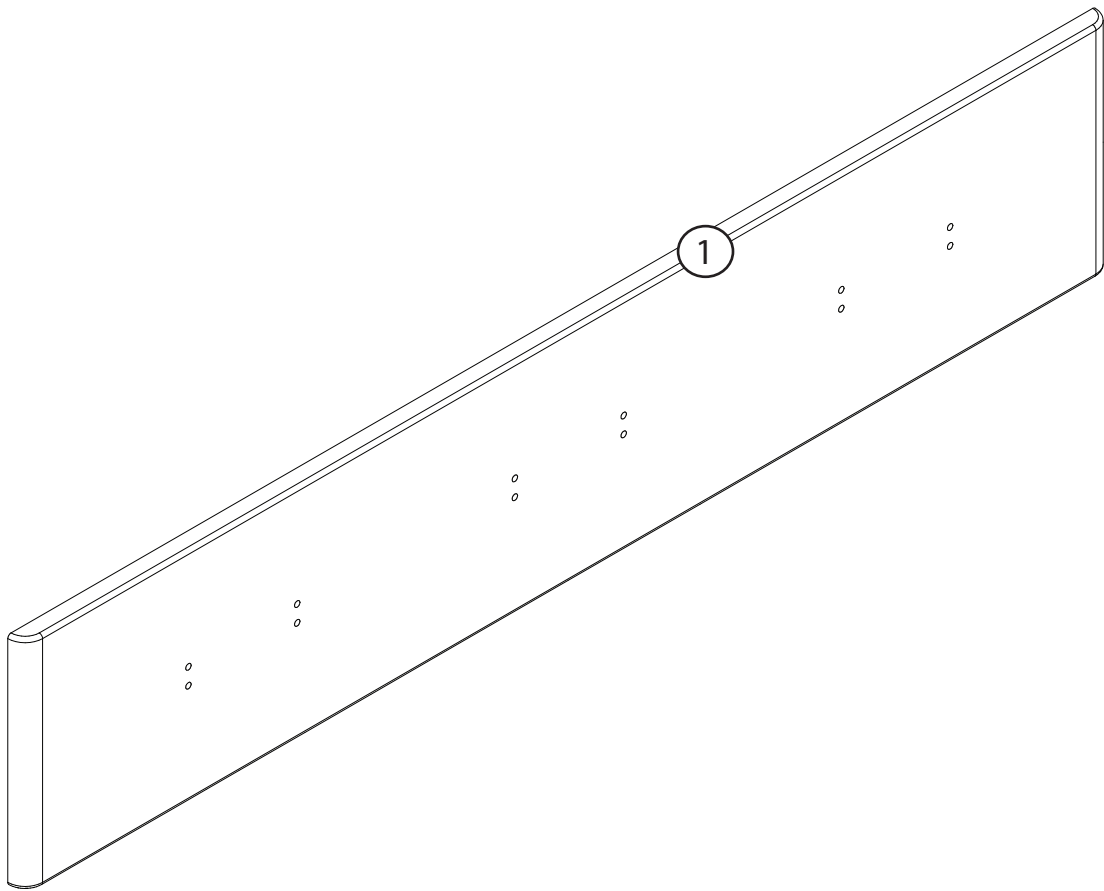
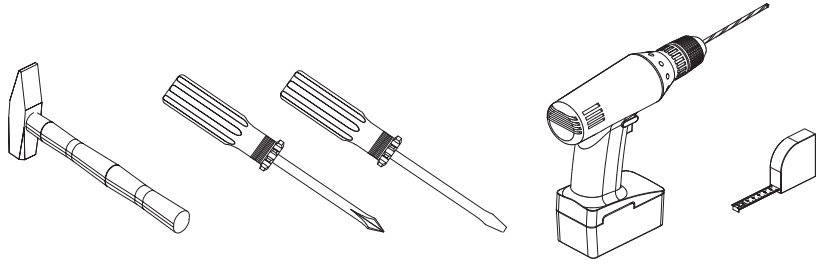
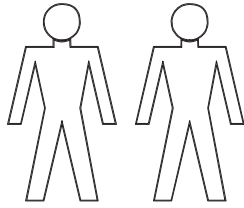

4 x

a

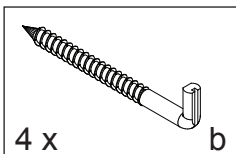

4 x

b

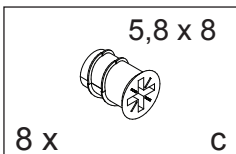

5,8 x 8

8 x

c

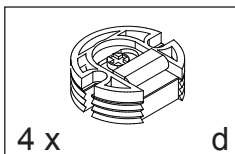

4 x

d

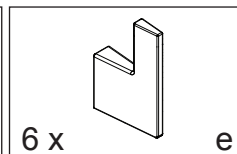

6 x

e

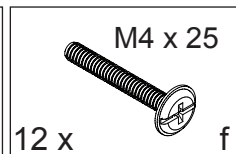

M4 x 25

12 x

f

# 1

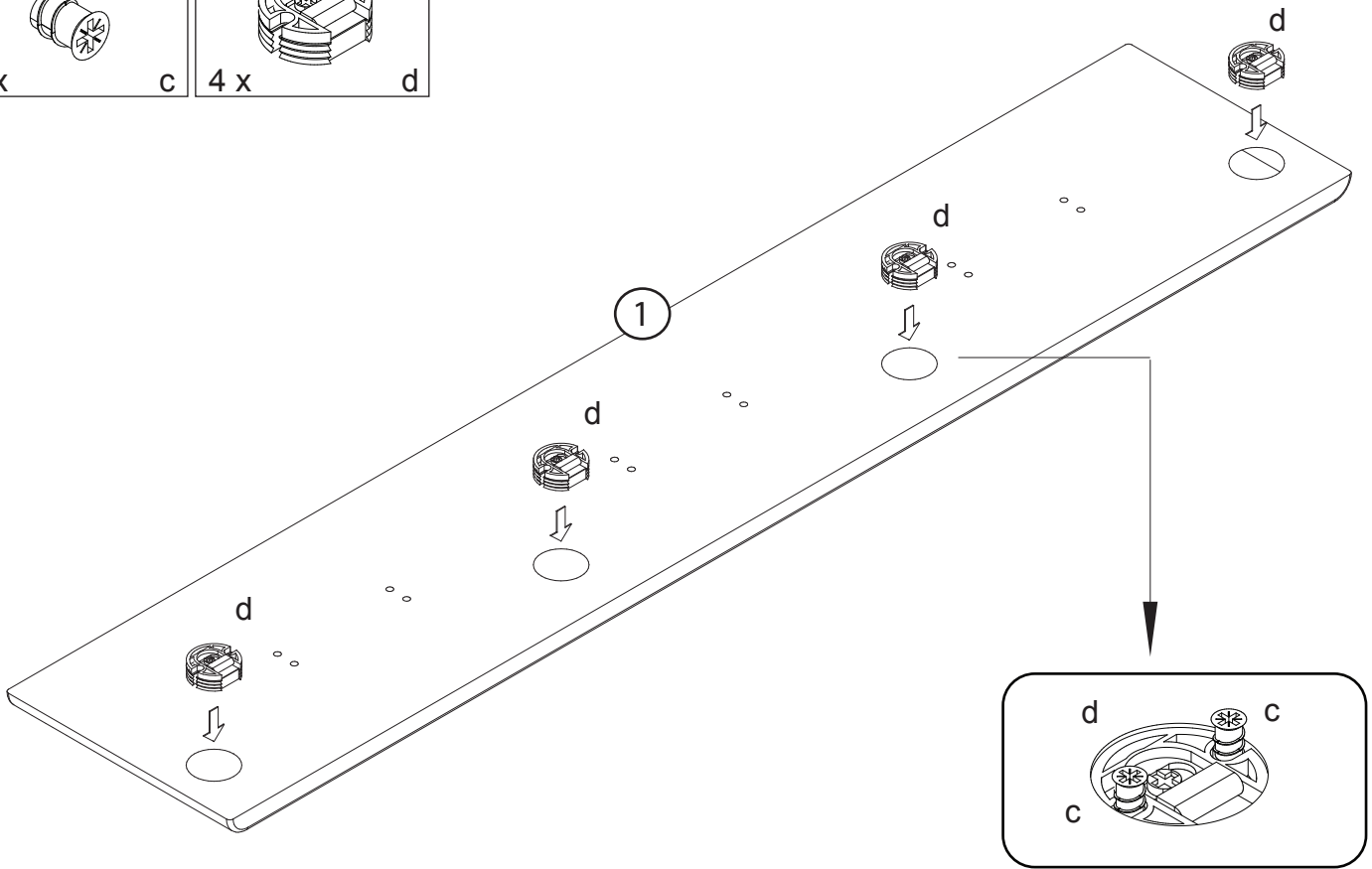
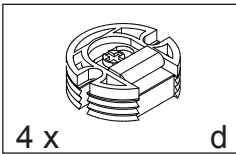
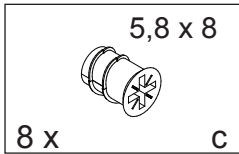

# 2

